

82-7502 Removing and Installing radio

Preceding work:
Ashtray removed (82-1285).

Operation no. of operation texts and work units or standard texts
and flat rates:
82-7520, 82-7601, 82-7608

A. With Mercedes-Benz mount (single block unit, push button control two-component set and CD player with radio control unit)

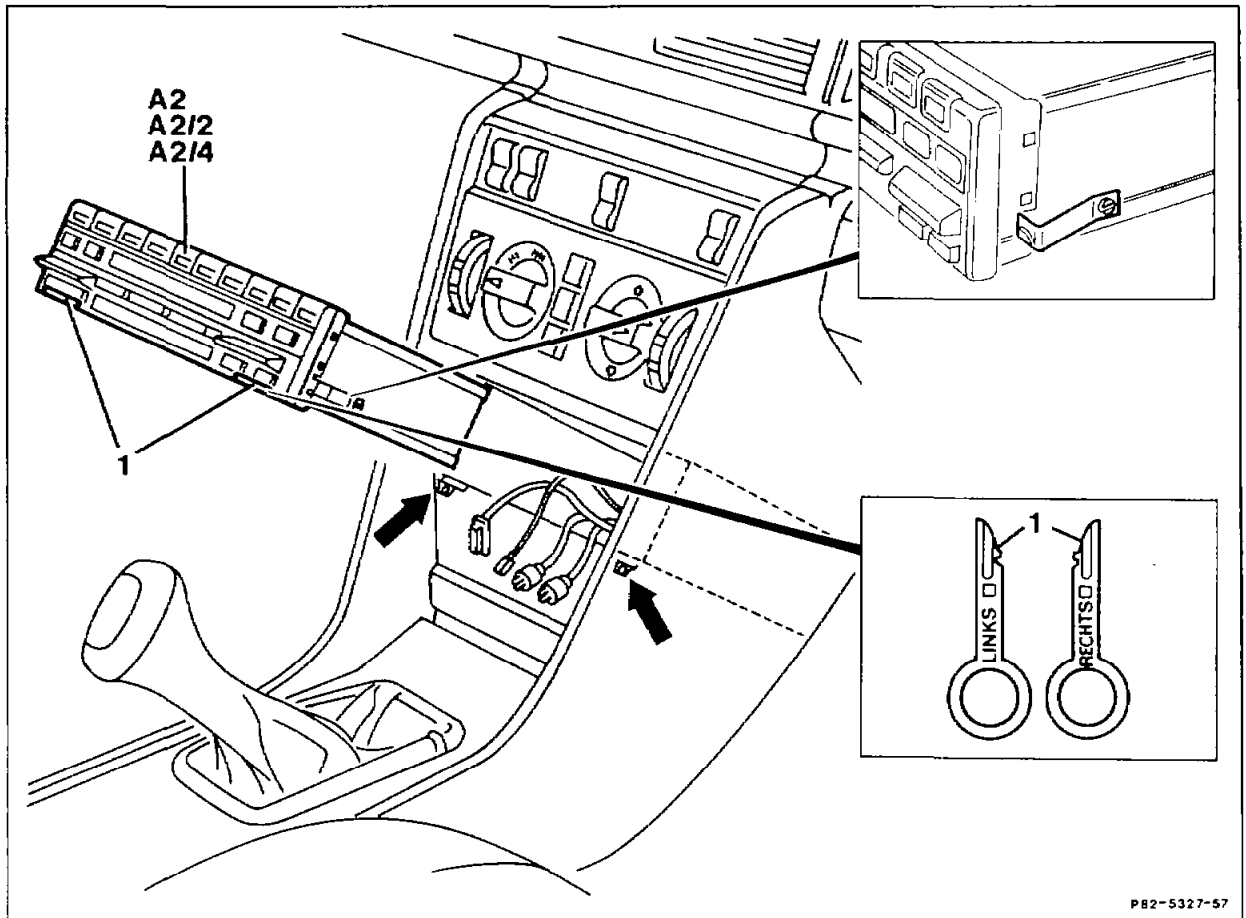

Ground cable at battery	disconnect, connect.
Clamping lever (arrows)	push down.
Radio (A2, up to approx. 09.90) or CD player and radio control unit (A2/2)	withdraw, insert.
Radio (A2) single-block set or radio control unit (A2/4, as of approx. 09.90)	insert removal plates (1) and withdraw radio or radio control unit, insert.

Note

Push back retaining springs on removed radio and withdraw plates (1). Radios were installed in the initial phase without the side retaining springs. On these radios, the removal plates do not lock in place. Removal and installation are performed as for the previous radio generation.

All radio versions

Electrical connections on radio disconnect, reconnect.

Note

On radio sets from approx. 09/87 or 11/87 up to 08/90 with variable code number.

Code number entered by customer (see operating instructions).

Note

New radio generation with programmed code. Enter code number from code card (see operating instructions).

Tool for removing

Designation	Part no.
Removal plates (1 set = 2 plates)	000 833 03 61

B. With universal mounting (Becker, old radio generation)

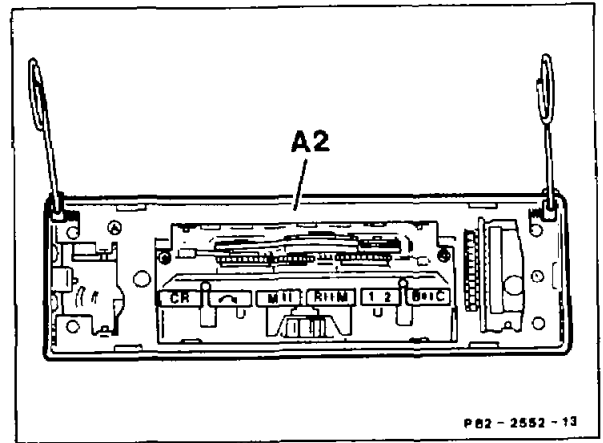
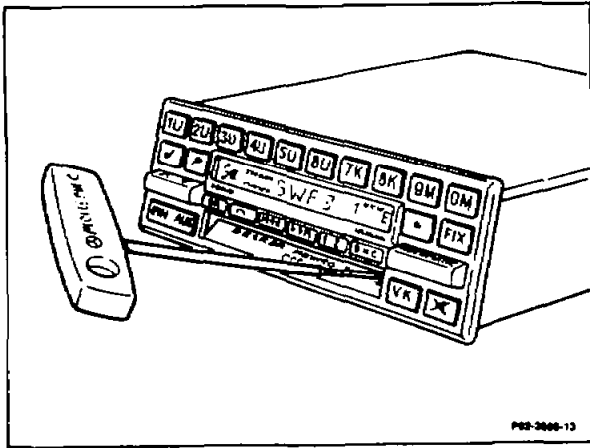

Front panel of radio

pull off, press on.

Withdrawal hook 140 589 02 33 00

Clamping lever

 Pull off only in the area indicated to avoid damaging the front panel.

Radio

pull down with assembly eyes or 1 mm dia. wire.

Electrical connections, antenna and speaker wiring

withdraw, insert.

unplug, plug in.

Note

If the standard radio mountings are fitted to the vehicle, remove the universal mountings on the radio before installing.

On radio sets from approx. 09/87 or 11/87 up to 08/90 with variable code number.

Code number

entered by customer (see operating instructions).

Special tool

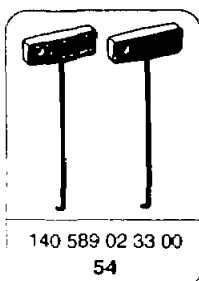

C. Running power supply cable terminal 30 from interior into component compartment (model 124.0 up to 01.86)

Engine speed-related interference to radio reception and cassette operation on model 124.0.

This interference may be transmitted inductively through the cable terminal 30 in the interior wiring harness, which runs below the radio set. To confirm diagnosis, withdraw radio set from the installation opening.

If the interference no longer exists, the cable terminal 30 in the interior wiring harness can be taken out of use as a remedial measure and a new cable terminal 30 run through the component compartment along the right-hand headlamp wiring harness.

Scope of work

- 1 Remove battery.
- 2 Disconnect cable terminal 30 at terminal block X4/10 (X35). Cut off cable shoe and insulate cable.
- 3 Remove cover behind the battery.
- 4 Remove cover of fuse and relay box and also of fuse carrier.
- 5 Remove instrument panel cover on bottom left.
- 6 Disconnect cable terminal 30 at terminal block X4, X4/1, cut off the 8 mm² cable immediately behind the cable shoe and insulate.

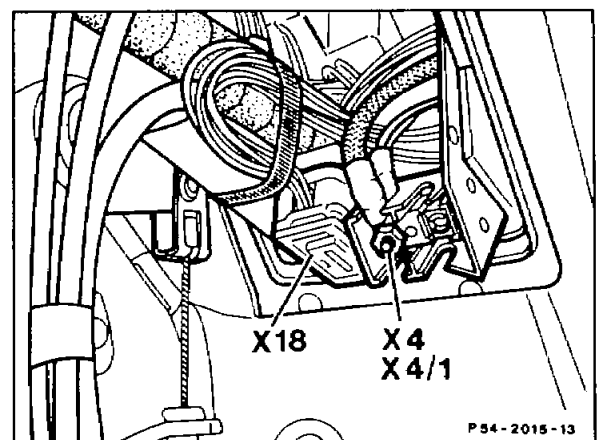
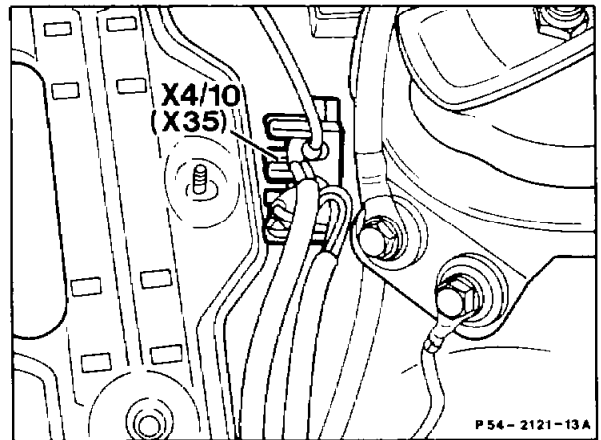

7 Connect new cable to terminal block X4, X4/1, run it through the fuse box (arrow) and along the headlamp wiring harness to the terminal block (X35) X4/10 and connect.

8 Re-install removed parts and perform functional check.

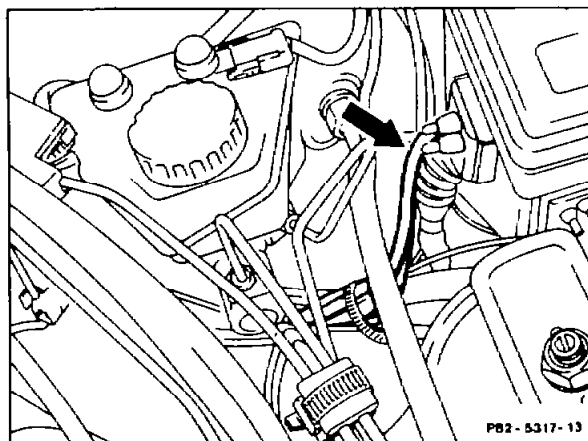

D. General

1. As of 08/85 the connection cables (power supply) for the Becker radio and the front speaker wiring are included in the standard scope of supply.

2. Power supply

1st version up to 07/85:

The cable set for the radio is plugged into the plug connection of the optional equipment block X30.

2nd version as of 08/85:

The connection for the radio is in the interior main wiring harness.

Becker car radio sets with variable anti-theft code (except USA)

Production breakpoint:

- Mexico Diversity code	09/87
- Grand Prix Cassette electronic Kurier LMU code	11/87
- Grand Prix electronic Kurier LMU code	11/87
- Europa Cassette electronic Kurier MU code	11/87
- Avus Cassette electronic Kurier MU code	11/87

These radio sets can be protected against theft by entering a code number of the customer's choosing (see operating instructions for radio set, enclosed).

The anti-theft protection is activated if the radio set is separated from the continuous power supply (terminal 30). The radio set cannot be restored to use unless the continuous power supply is assured and the correct code number has been entered in the radio set. If the

programmed code number is lost, the radio set must be decoded by the manufacturer.

Federal Republic of Germany	Export countries
Becker Autoradiowerk GmbH D-7516 Karlsbad-Iltersbach	Agency or service centers of Becker Autoradiowerk GmbH

(USA) radio as of model year 1986

If the radio is removed when the anti-theft warning system is switched on, the set is rendered unusable and cannot operate again until repaired at a Becker service point.

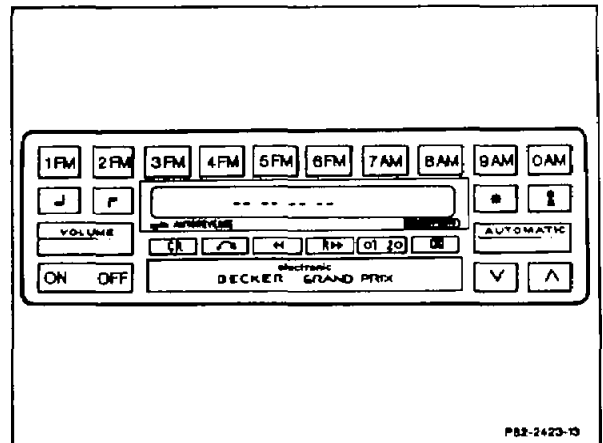

(USA) radio as of model year 1990

The Becker Grand Prix radio is replaced by the Mercedes-Benz radio which differs in the following respects:

- improved reception properties in the FM range
- AM reception only in mono
- station search only 2-stage
- programmed anti-theft coding.

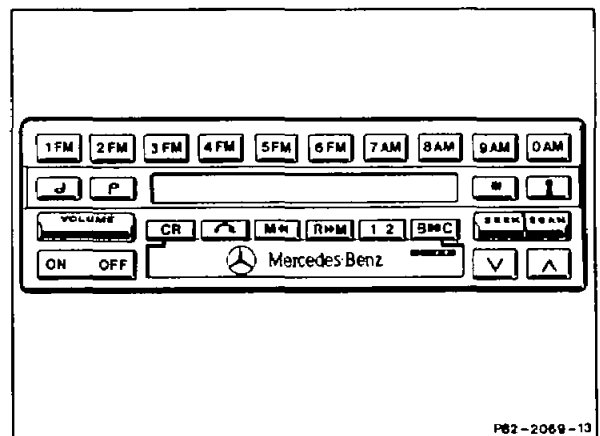

Becker 2000 (from approx. 09/90 to 09/93)

As of approx. 09/90 the Becker radio 2000 with four speakers and balance control has been installed. These radios are programmed with a fixed code no.

The code number is recorded on a code card which is enclosed with the radio set.

If the radio is separated from the power supply (terminal 30), e. g. is removed (theft) or by disconnecting the battery, an electronic interlock in the radio is activated.

The radio is operational again after entering the code number.

Becker Europa 2000
(standard class)

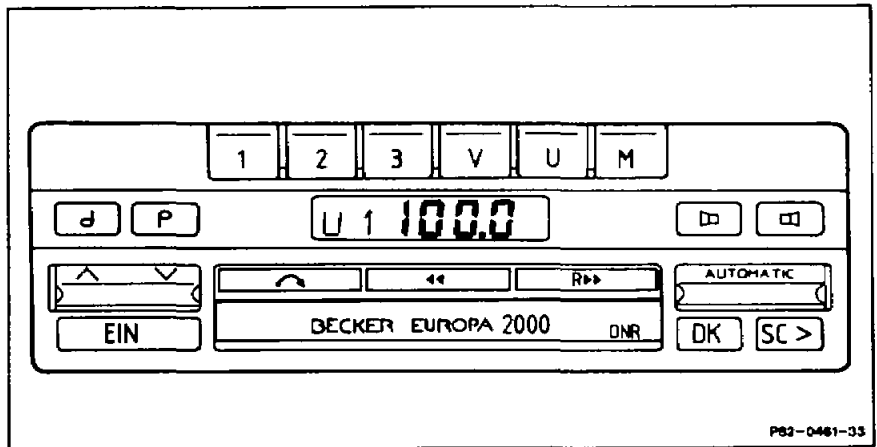

Becker Grand Prix
(mid class)

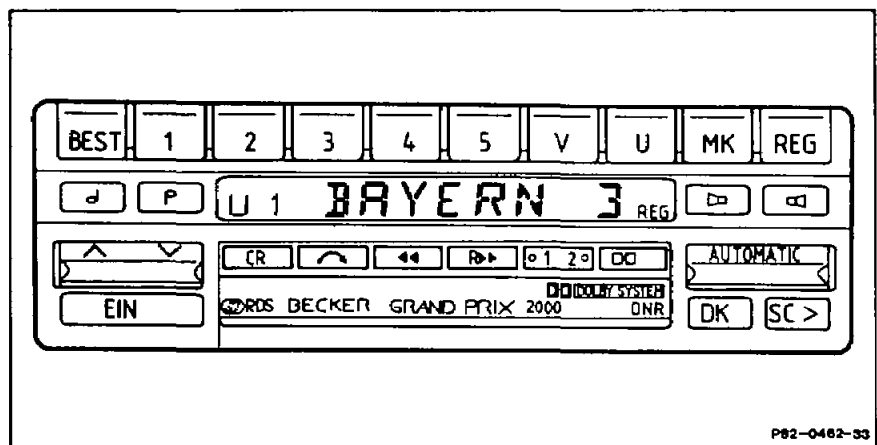

Becker Mexico 2000
(top class)

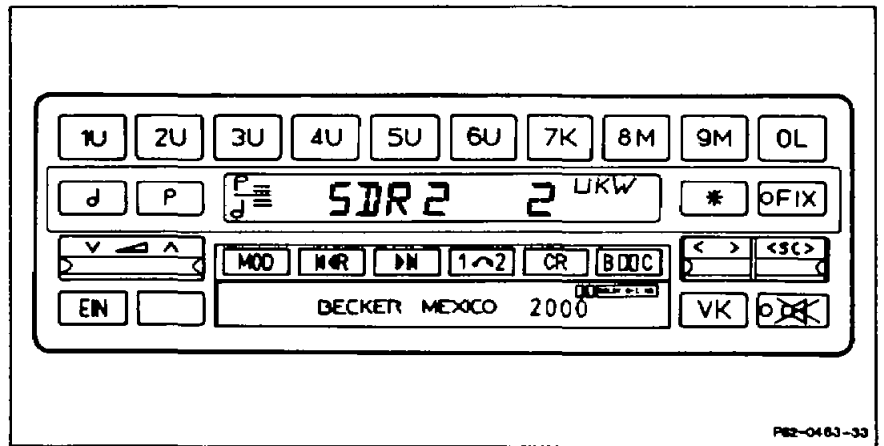

PEZ-0463-33

Becker Grand Prix 2000 with
Mercedes-Benz trade mark
(USA only)

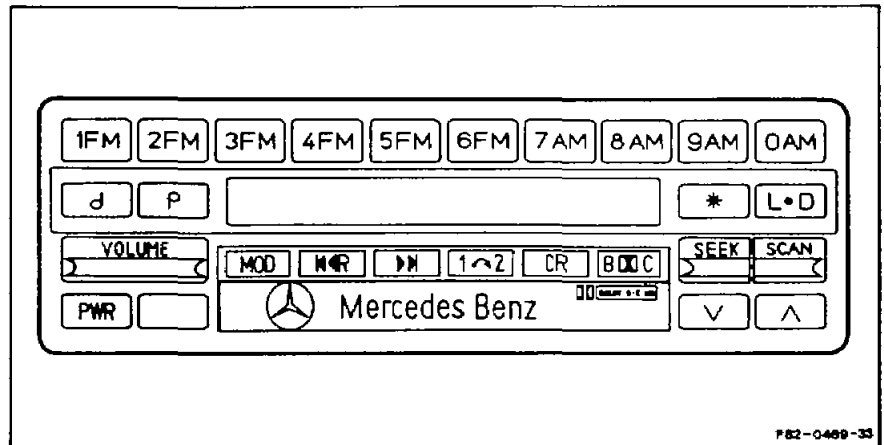

F 82-0469-33

Note

When the key in the steering wheel lock is turned back from position 1 to position 0, the Becker Mexico 2000 and the Becker Grand Prix 2000 (USA) radios remain on for a further 3 seconds approximately. These radios can be switched on and off additionally when the key is removed by pressing the On/Off button. The radio switches off automatically after one hour. It can then be switched on again. The power is supplied through terminal 30.

Radio (as of approx. 10/93)

Three MB versions (Classic, Special, Exquisit) are available as special equipment.

These radios are single-block units with four output stages and integrated balance control.

Classic version

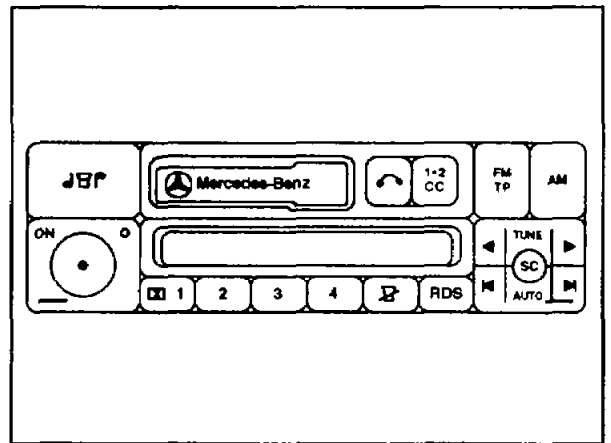

P82-6256-13.

Special version

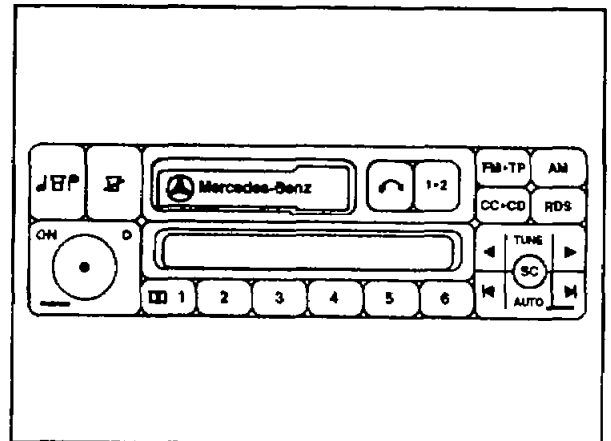

P82-6254-13

Exquisit version

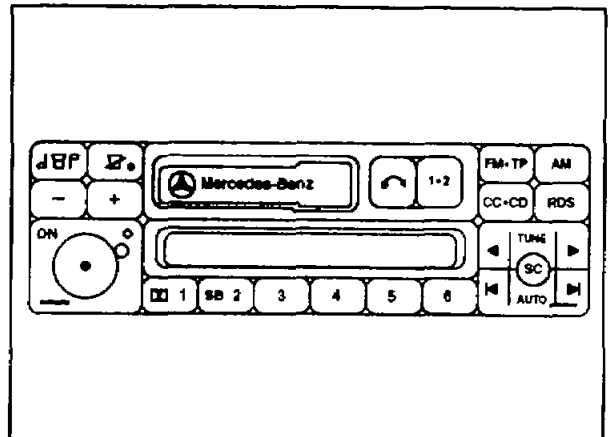

P82-6255-13

Exquisit version (Japan)

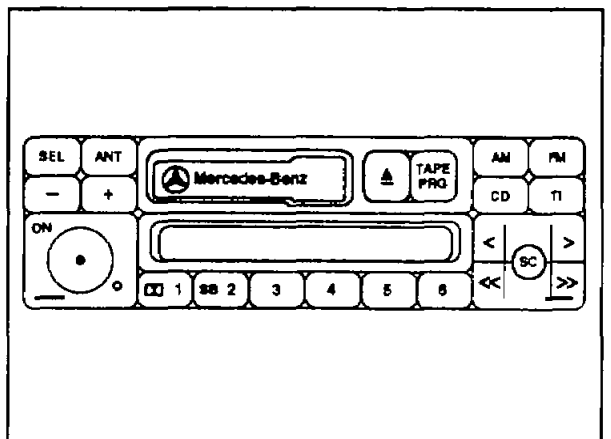

P82-6261-13

Exquisit version (USA)

The radio can be adapted to the speaker system (standard system or sound system) by means of a coding feature (arrow) in the wiring harness.

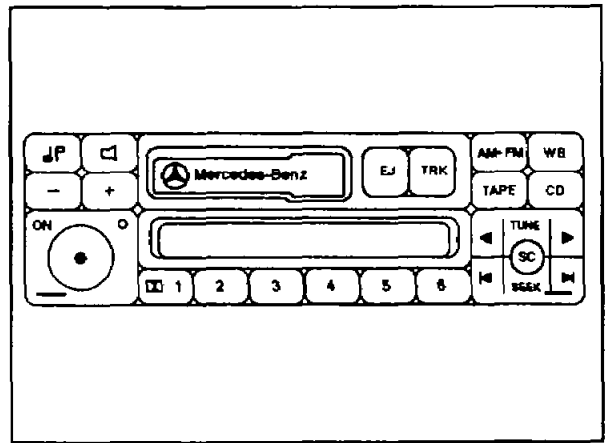

P82-8263-13

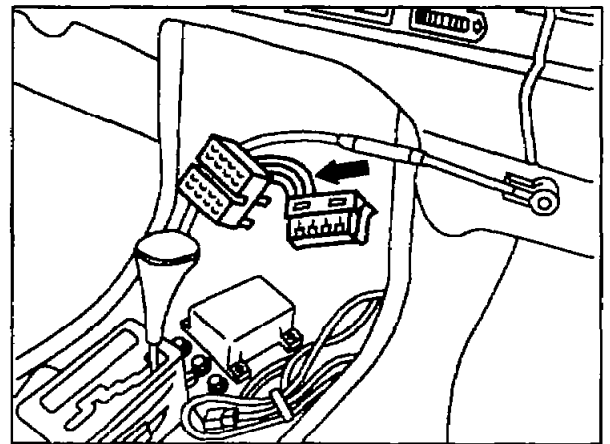

P82-8246-13.

Two copies of the code card containing the type of unit, serial number and code number of the radio or radio control unit are included with each radio or radio control unit.

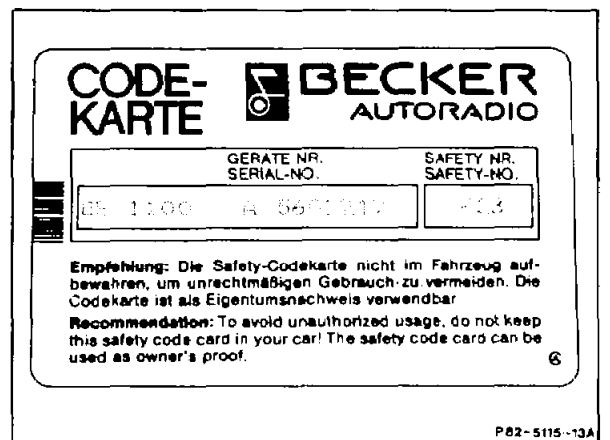

P82-5115-13A

An identification card containing the serial number is included for the receiver and amplifier stage of two-component radios and CD players with changers.

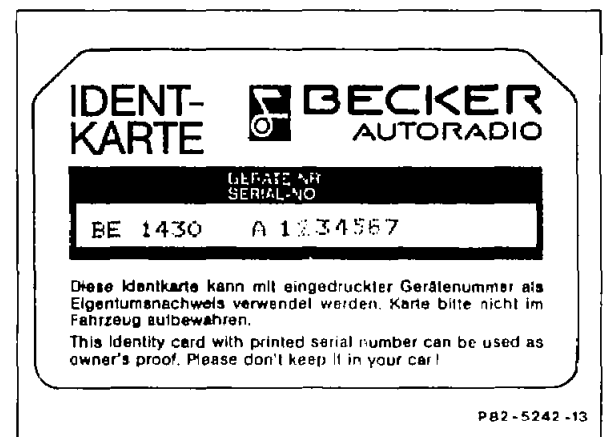

P82-5242-13

E. Infrared remote control

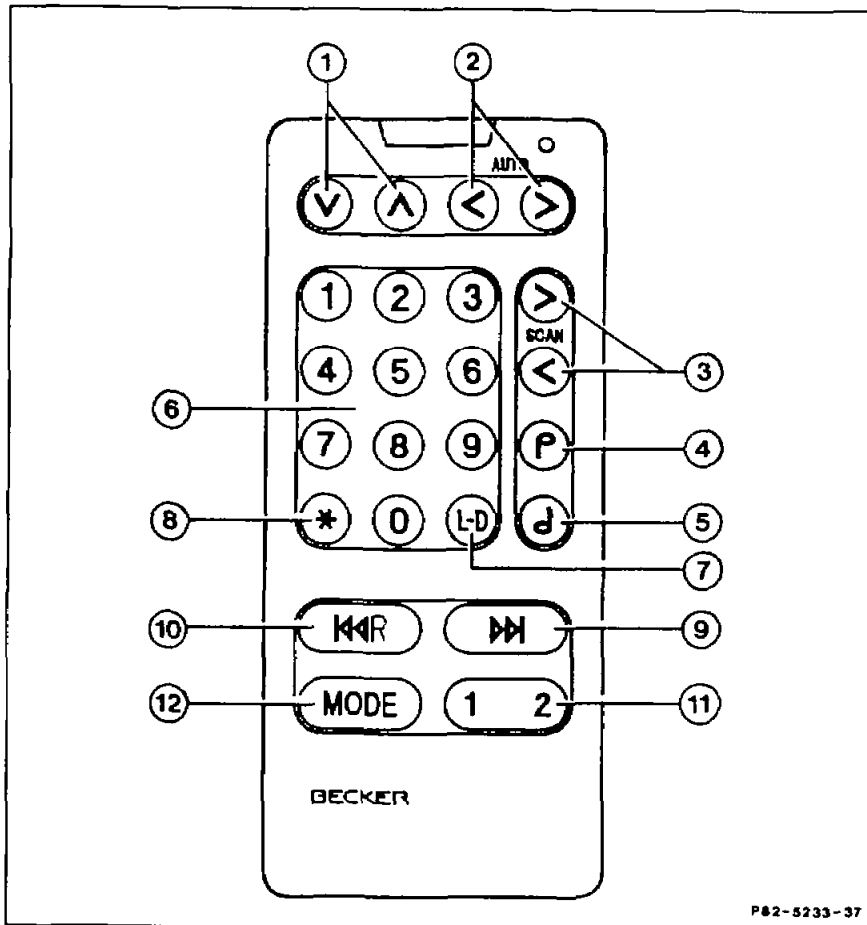

- | | | | |
|---|---|----|--|
| 1 | Volume buttons | 7 | Dummy button |
| 2 | Automatic search buttons | 8 | Function button |
| 3 | Scanning button | 9 | Forward/fast forward title search button |
| 4 | Right treble/balance button | 10 | Reverse/fast reverse title search button |
| 5 | Left bass/balance button | 11 | Track selection button |
| 6 | Wave range buttons, station buttons, buttons for selecting CD compartment | 12 | MODE button |

The two-component radios Becker Mexico 2000, Becker Grand Prix 2000 (USA) and Exquisit version are prepared for infra-red remote control available as special equipment. This allows the primary functions (radio, cassette and CD player with changer) to be controlled from the rear of the vehicle.